

Preparation

**Part Number: PW301-02009**

**Kit Contents** (see next page for description)

Item #	Quantity Req.	Description
1	1	Front Cross Bar
2	1	Rear Cross Bar
3	2	Key
4	4	Insert
5	1	Front Right Cover
6	1	Front Left Cover
7	1	Rear Right Cover
8	1	Rear Left Cover
9	1	Installation Torque Tool
10	1	Installation Instructions

**Hardware Bag Contents**

Item #	Quantity Req.	Description

**Additional Items Required For Installation**

Item #	Quantity Req.	Description

**Conflicts**

None
------

**Recommended Tools**

<b>Personal &amp; Vehicle Protection</b>	<b>Notes</b>
Blankets	Protect the roof
<b>Special Tools</b>	<b>Notes</b>
<b>Installation Tools</b>	<b>Notes</b>
Scissors	
Tape Measure	Metric
Nylon Panel Removal Tool	e.g. Panel Pry Tool #1 Toyota SST# 00002-06001-01
<b>Special Chemicals</b>	<b>Notes</b>
Cleaner	VDC Approved Surface Cleaner
Soap & Water Solution	DIO Installations

**General Applicability**

MY19 and newer Corolla Hatchback models
---

**Recommended Sequence of Application**

Item #	Accessory
1	
2	
3	

\*Mandatory

**Vehicle Service Parts** (may be required for reassembly)

Item #	Quantity Req.	Description
1		
2		
3		

**Legend**

 **STOP:** Damage to the vehicle may occur. Do not proceed until process has been complied with.

 **OPERATOR SAFETY:** Use caution to avoid risk of injury.

 **CAUTION:** A process that must be carefully observed in order to reduce the risk of damage to the accessory/vehicle and to ensure a quality installation.

 **TOOLS & EQUIPMENT:** Used in Figures calls out the specific tools and equipment recommended for this process.

 **REVISION MARK:** This mark highlights a change in installation with respect to previous issue.

 **SAFETY TORQUE:** This mark indicates that torque is related to safety.

**Procedure**

Care must be taken when installing this accessory to ensure damage does not occur to the vehicle. The installation of this accessory should follow approved guidelines to ensure a quality installation.

These guidelines can be found in the "Accessory Installation Practices" document.

This document covers such items as:-

- Vehicle Protection (use of covers and blankets, cleaning chemicals, etc.).
- Safety (eye protection, rechecking torque procedure, etc.).
- Vehicle Disassembly/Reassembly (panel removal, part storage, etc.).
- Electrical Component Disassembly/Reassembly (battery disconnection, connector removal, etc.).

Please see your Toyota dealer for a copy of this document.

**1. Check the Kit & Warnings.**

(a) Verify the kit contents (Fig. 1-1).

- (1) A1 = Front cross bar (1 pc)
- (2) A2 = Rear cross bars (1 pc)
- (3) B = Covers (4 pcs) & keys (2 pcs)
- (4) C = Insert (4 pcs)
- (5) D = Installation tool (1 pc)

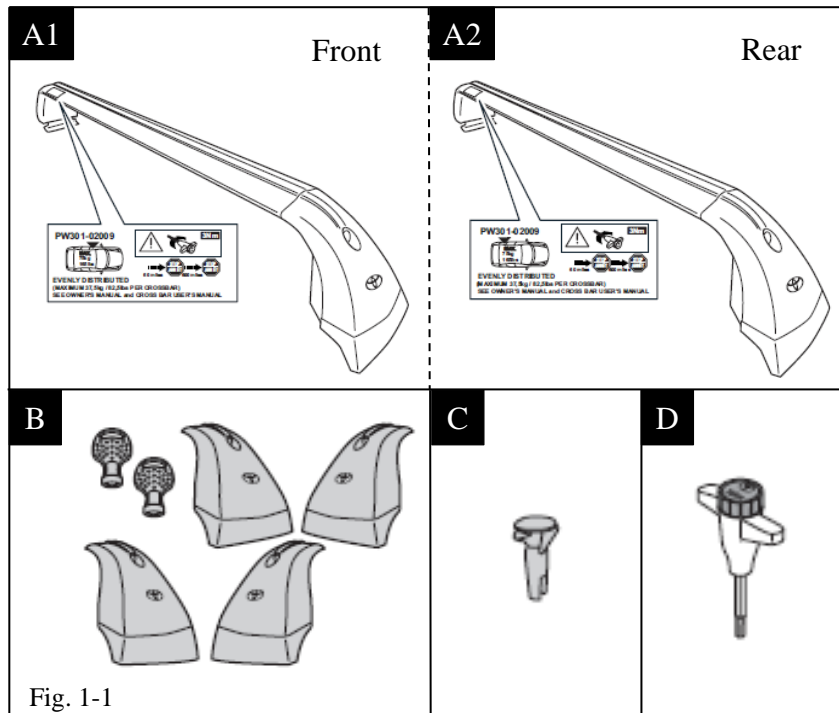

Fig. 1-1

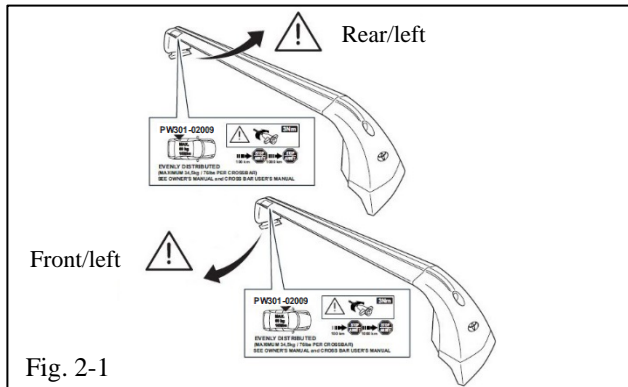

Fig. 2-1

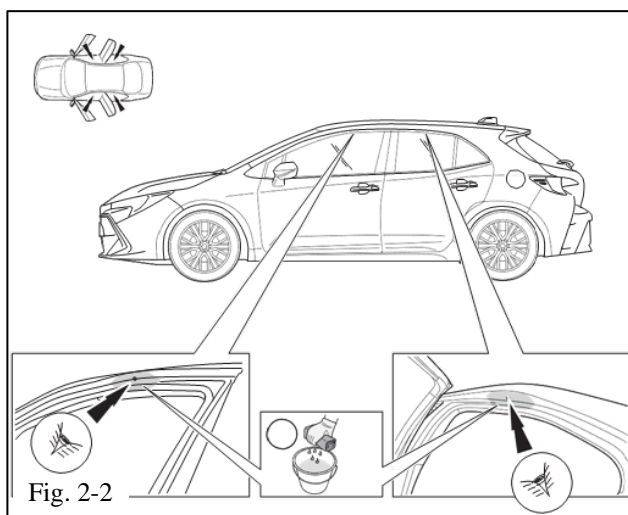

Fig. 2-2

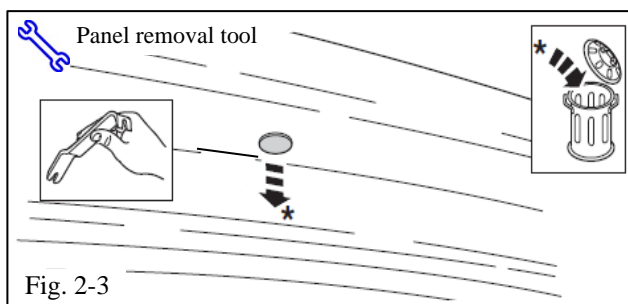

Fig. 2-3

## 2. Prepare to Install the Cross Bars.

- (a) Identify where on the vehicle each cross-bar foot will mount (Fig. 2-1).

**⚠ NOTE:** The warning label on the left side indicates the vehicle position, front or rear.

- (b) Protect the roof with a blanket if needed.

- (c) Open all four doors and clean the indicated mounting area with VDC-approved cleaner or soap and water solution (Fig. 2-2).

- (d) Use a plastic prying tool to remove the 4 caps and discard them (Fig. 2-3).

**⚠** (e) Using scissors, neatly cut open the plastic bag containing the installation torque tool (item D) and the resealable bag of plastic inserts (item C).

- (f) Remove the 4 plastic inserts (item C) from the resealable plastic bag.

- (g) Retain the non-resealable bag for storage of the installation torque tool and keys.

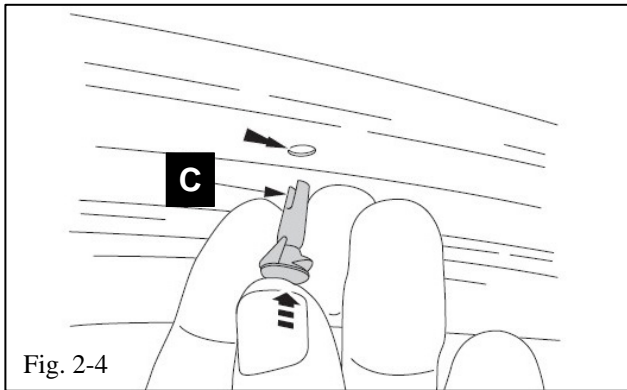

(h) Install the 4 plastic inserts (item C) into each hole at the top of the door frame (Fig. 2-4).

**!** (i) Use the provided installation torque tool (item D) to loosen the clamp assemblies on the cross bars enough to allow for installation.

**3. Install the Front and Rear Cross Bars**

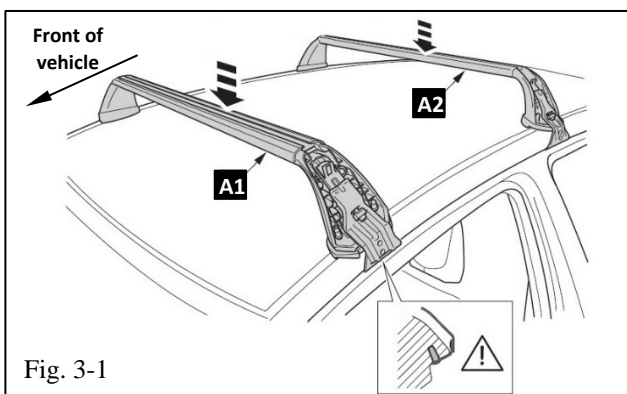

(a) Carefully place the front cross bar (item A1) where the pins are aligned with the front mounting holes (Fig. 3-1).

**!** **NOTE:** Do not move or slide the cross bar along the vehicle body.

(b) Carefully place the rear cross bar (item A2) where the pins are aligned with the rear mounting holes (Fig. 3-1).

**!** **NOTE:** Do not move or slide the cross bar along the vehicle body.

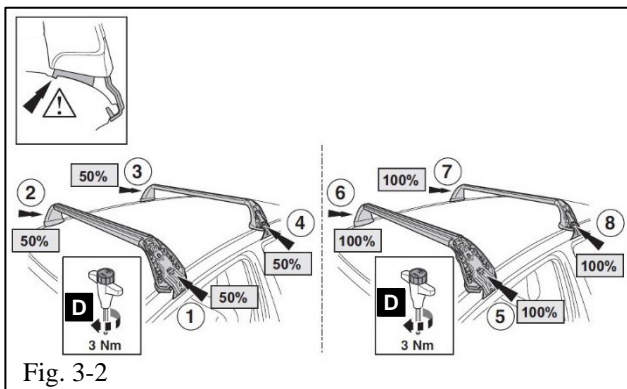

(c) Use one hand to fully seat the locating pin into the holes in the door frame, then use the provided installation torque tool (item D) to partially tighten (about 50%) each support (Fig. 3-2).

**!** **NOTE:** Ensure that the cross-bar supports are placed properly onto the roof by making sure the rubber pad is fitted in the drip rail and the locating pins are fully seated into the holes in the door frame (Inset, Fig. 3-2).

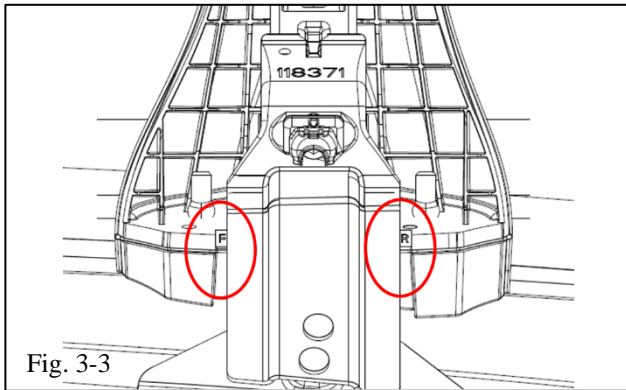

**⚠ NOTE:** Confirm bracket is center between F and R on cross bar bracket (Fig. 3-3).

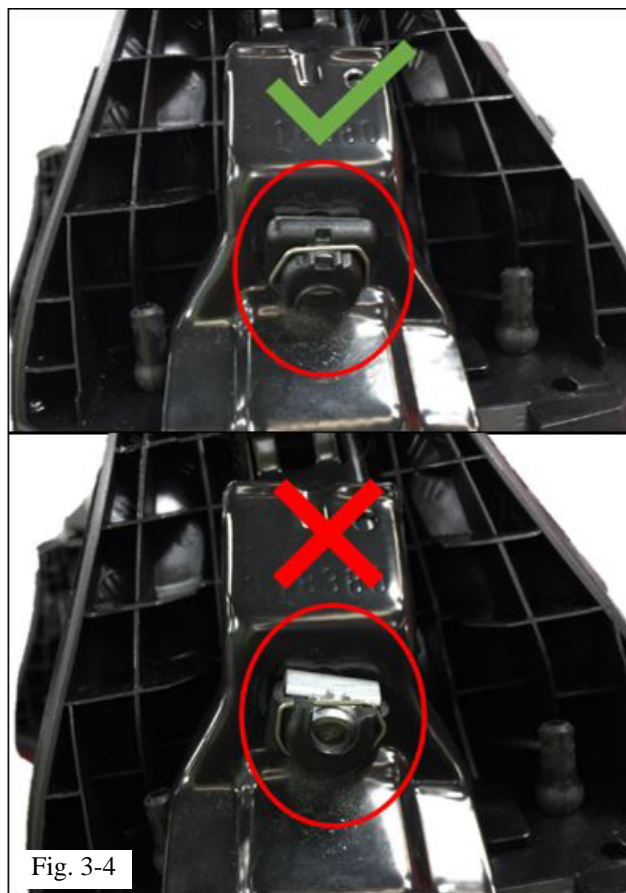

**⚠ NOTE:** Confirm tightening mechanism is right-side up before tightening (Fig. 3-4).

(d) Tighten each support until the installation torque tool (item D) clicks (100%).

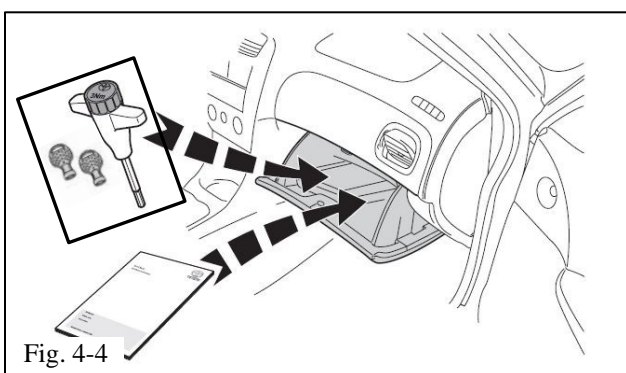
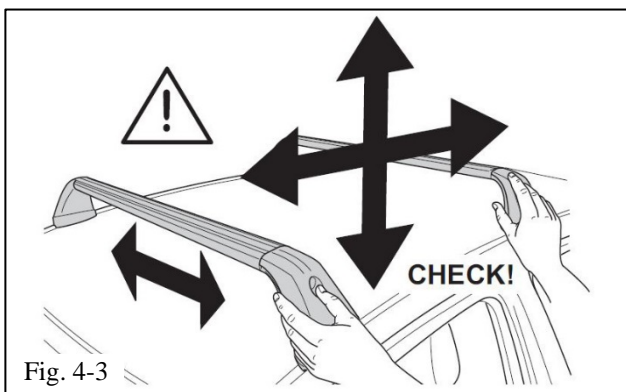
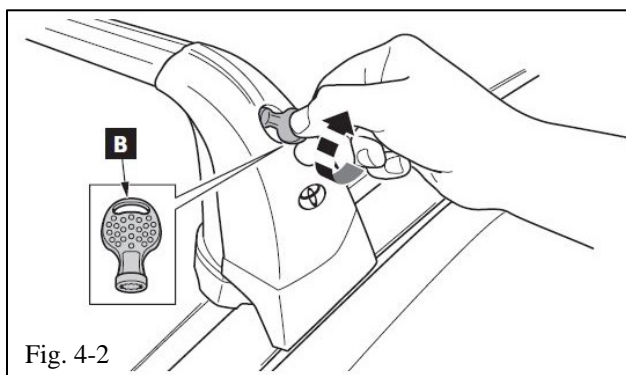
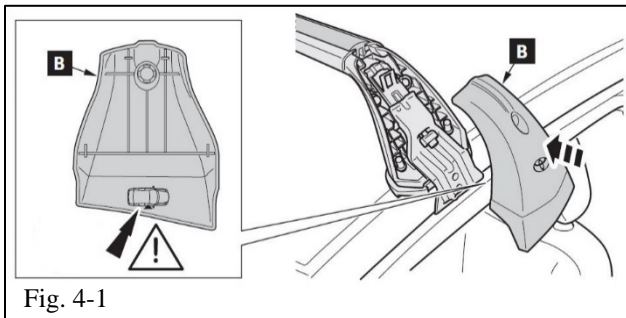

**4. Complete the Installation.**

(a) Install the covers (item B) onto each support. Each cover has its location shown on the inside surface (Fig. 4-1).

 (b) Use one of the keys (item B) to lock the covers into position by turning the key clockwise approximately ¼ turn (Fig. 4-2).

 **NOTE:** Both keys are the same.

(c) Remove the key (item B) and place it in the original plastic bag.

(d) Check that the cross bars are tight and do not move (Fig. 4-3).

 (e) Place the manual and plastic bag [with cover keys and installation tool] in the glove compartment (Fig. 4-4).

Checklist - these points **MUST** be checked to ensure a quality installation.

<u>Check:</u>	<u>Look For:</u>
<p><u>Accessory Function Checks</u></p> <ul style="list-style-type: none"><li><input type="checkbox"/> Ensure the cross bars are secure and in correct position</li><li> <input type="checkbox"/> Ensure the covers are securely attached</li><li><input type="checkbox"/> Ensure throw-ins are in glovebox</li><li><input type="checkbox"/></li></ul>	<p>Cross bar knobs are tight and each clamp pin is properly inserted in the door frame hole</p> <p>Covers are securely in place and locked</p> <p>Manual and plastic bag that contains installation tool and cover keys</p>
<p><u>Vehicle Function Checks</u></p> <ul style="list-style-type: none"><li><input type="checkbox"/></li><li><input type="checkbox"/></li><li><input type="checkbox"/></li></ul>	
<p><u>Vehicle Appearance Check</u></p> <ul style="list-style-type: none"><li><input type="checkbox"/> After accessory installation and removal of protective cover(s), perform a visual inspection.</li></ul>	<p>Ensure no damage (including scuffs and scratches) was caused during the installation process.</p> <p>(For PPO installations, refer to TMS Accessory Quality Shipping Standard.)</p>